



DISPLAYS2GO
CONNECTING PEOPLE & BRANDS WITH THE WORLD

DISPLAYS2GO DIGITAL 32" Slim Profile Digital Signage USER MANUAL

Model: DH32NLB

Description: 32" Slim Profile Digital Signage



Scan QR code to visit
the product page:



FCC ID: 2AITM-IOT-3288A

This device complies with Part 15 of the FCC Rules. Operation is subject to the following two conditions:

- (1) this device may not cause harmful interference, and
- (2) this device must accept any interference received, including interference that may cause undesired operation.

Any changes/modifications to this equipment not approved by the party responsible for compliance could void the user's authority to operate the equipment.

Contents

Contents	-----	
2 Features	-----	
Safety Warnings and Precautions	-----	4
Warning	-----	5
Caution	-----	6
Parts and Connection	-----	7
Packing List	-----	7
Interfaces	-----	7
Installation steps	-----	7
Remote Control Instructions	-----	8
Description Of Basic Operation	-----	9
Android 11 Operating System (3399)	-----	9
1. Functional description	-----	10
2. Introduction to system settings	-----	12
3. Function instructions	-----	14
DiViEx APP Introduction	-----	22
Technical Specifications	-----	27
Names and Contents of Toxic and Hazardous Substances or Elements in the Product	-----	32

Features

- ◆ Embedded with Android 11 smart operating system and unique UI design, bringing you a more convenient operation and better visual experience.

- ◆ Support USB mouse and keyboard, realizing easy manipulation like a computer. Using a mouse for set up is recommended.

- ◆ High-quality LCD screen as the display, no flicker, low radiation, greatly reducing eye fatigue, eye protection, high brightness, high contrast, and wide viewing angle; ultra-fast response time greatly reduces ghosting of fast moving images.

- ◆ Progressive image processing and industry-leading motion compensation technology improve the flickering and blurring in the edges of motion picture.

- ◆ Dynamic contrast technology can significantly improve the clarity and contrast of various screens.

- ◆ Multi-channel USB interfaces, supporting HD media streaming.

- ◆ Platform and configurations:

Hardware platform: ARM Cortex-A72, 1.8GHz Quad core processor;

Chip: Mali-T76x series GPU;

High capacity memory: DDR4 4GB, inter FLASH/32GB NAND.

- ◆ Support 4K Ultra Full HD videos and pictures; Built-in HDMI1.4, 1080p output and 3D output;

- ◆ Support Full HD video format:

Video: RMVB, FLV, MPEG1/2/4, AVI, DIVX, XDIV, WMV9, H.264, VC-1, MOV, MKV, MP4, TS, M2T, VOB.

Audio: MP3, WMA, WAV, EAAC+, MP2, dec, Vorbis (Ogg), AC3, FLAC (Lossless audio), APE (Lossless audio), BSAC;

Pictures: BMP/PNG/GIF/JPEG (4088*4088);

- ◆ Support webpage/Flash playback, can achieve strong touch interactive platform rely on the touch interactive of webpage/Flash;

- ◆ Input function:

- 1) Support multi touch, resistive touch, capacitive touch, IR touch, with touch screen calibration;

- 2) Support remote control;

- 3) Support USB mouse/keyboard;

- ◆ Output function: Support landscape and portrait mode once power on;

- ◆ Multi storage media: Support U stick and TF card;

- ◆ Multi languages; support TTF vector font, distortion less display;

- ◆ Clock display: Built-in clock IC, it could update time information after networking, correct system time automatically.

- ◆ Support Strong network: Support LAN, WIFI and 3G (extend Bluetooth);

- ◆ Combined with CMS Software, it could make video, Television images, pictures, animation, text, documents, web pages, streaming media, database data into one wonderful section program, which also could be launched to terminals in different places through network, show the great graphics and real-time information to people at different appointed places.

Safety Warnings and Precautions





Thank you for purchasing the high-performance multi-functional Digital Signage from Displays2go. We have considered the factors to ensure personal safety in product design and have tested rigorously at the factory. However, improper installation and use may result in electric shock and fire.

In order to safely use, maximize performance of the unit and extend the life of the product, please read and follow all instructions carefully before using the product.

Keep the instructions for future reference.

We strongly recommend using a surge protector, or a power strip with internal circuit breaker to prevent damages to the digital signage.

Symbol Legends:

-  **Warning: May cause personal injury or death**
-  **The operation is prohibited**
-  **Caution: May cause damage or property loss**
-  **The operation must be executed**

If any of the following occurs:

- Power outage or instable voltage.
- Abnormal sound or smell from the unit.
- AC power cord is damaged.
- Digital Signage is damaged due to drop, knock or impact.
- Any liquid or foreign matters fall into the enclosure.



Turn off the Digital Signage immediately, pull out the plug from the power outlet, and ask the authorized personnel for maintenance timely.

-  **If coal gas or other flammable gas leaks, do not pull out the plug of the LCD Digital Signage or other electrical appliances; instead, turn off the gas valve immediately, and open the doors and windows quickly.**



WARNING

- ⊘ ● Do not use power supply other than AC 110V, 60Hz.
- Cut off the power supply before connecting or disconnecting any cables.
- Do not place the Digital Signage at any instable positions, or else it may be damaged or
- cause fire.
Do not place the Digital Signage in the positions such as:
 - 1.The environment subject to direct strong sunlight, moisture, extreme temperature or too much dust;
 - 2.The environment with flammable or explosive materials;
 - 3.The environment with flammable or corrosive gases;
- Do not use damaged or inappropriate power outlets and ensure that the plugs and outlets contact properly.
- Do not let dust or metal deposits adhere to the plugs and outlets.
- Do not damage the power cords:
 - 1.Do not modify the power cords;
 - 2.Do not place heavy objects on the power cords;
 - 3.Keep the power cords away from heat source;
 - 4.Do not pull the cord to remove the plug.
- Do not connect too many plugs to one outlet in parallel, or else it may cause fire due to excessive power consumption.
- Do not approach the Digital Signage with open flame (e.g. a lighted candle), or else it may cause electric shock or fire.
- Do not put any sharp objects, metal or liquid into the vents or let them touch the signal terminals to avoid short circuit, product damage, and electric shock.

- ⊘ Do not touch the plugs with wet fingers, or else it will cause electric shock.

- ⚠ Do not use the Digital Signage in stormy weather, especially when there is lightning; instead, please disconnect the power and antenna plugs to avoid lightning strike.

- ⊘ Do not disassemble the Digital Signage without permission, or else it may cause electric shock or fire. Please ask qualified technician for repair.

Note:

Contact local dealer if you have questions about the operation, debugging and connection of the unit; if the unit doesn't work normally, please cut off the power immediately and consult the dealer. The unit is class-A product, which may cause radio interference in living environment. In this case, please take feasible measures, and use power plug as the disconnection device.



CAUTION

- Do not let children climb onto the Digital Signage.
- Keep the small parts away from children to prevent them from swallowing.
- If the Digital Signage won't be used for a long time, please turn it off and pull out the power plug.
- To adjust the position of the Digital Signage, please disconnect all power cords and move slowly to avoid tip over.
- Do not scratch or knock the LCD with hard object, or twist and squeeze the LCD.
- Do not turn on the unit immediately when it is moved from a place with low temperature to high temperature, or else it will cause condensation and malfunction.
- Before cleaning the Digital Signage, please pull out the power plug; wipe with soft cloth; do not use industrial chemicals; prevent foreign matters from entering the machine. Improper cleaning (such as cleaning solution, water) may damage the product, erase the printed information, and even cause damage of the components if fluid flows in, resulting in machine failure.
- If the unit displays the same screen for a long time or the moving picture has fixed text or icon, it will leave ghosting on the screen and won't disappear when the unit is turned off; it is normal and isn't covered by the warranty.
- The power of the Digital Signage can be cut off by pulling out the plug.
- If the LCD screen ruptures and the liquid splashes on the skin, please rinse for 15 minutes with clean water immediately, and consult your doctor.
- Do not apply pressure on the panel.
- Use the Digital Signage properly: Use in proper lighting conditions; insufficient lighting or long time watching will impair your eyesight.
- When the plug or coupler is used as disconnection device, it should be easy to operate the device.
- Insert the plug into the outlet properly, or else it may cause sparks and fire.
- The technical specifications printed herein and on the packaging are subject to change without prior notice. The Manual may be slightly different from actual operation, and the latter is applicable.

Parts and Connection

Packing List

Name		Name	
1 Digital Signage	●	1 Power Cord	●
1 Remote Control	●	1 Hanging bracket	●
1 Operation Manual	●		

Interfaces

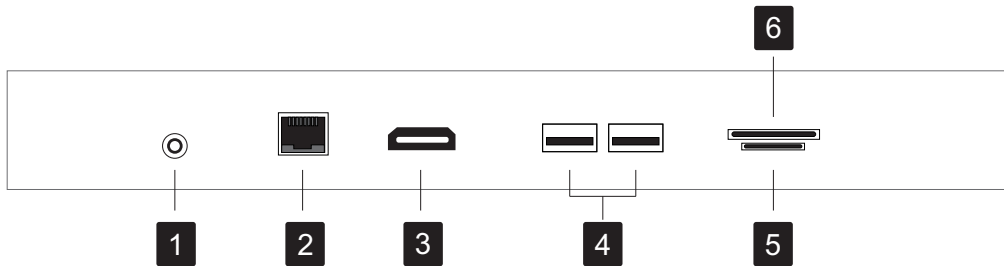

Note: Please pull out the power plug before installing or disassembling the unit!

- 1** Audio OUT ports: This port is the audio signal output port.
- 2** RJ45 Port: This is the grid interface, Support connection to 100 mbit/g network.
- 3** HDMI OUT: This port is used to connect HDMI signals.
- 4** USB port: This port is for software upgrades and playback of audio and video files from USB sticks.
- 5** TF Port : This is the TF card interface
- 6** SIM Port : This is the SIM card interface

Installation steps

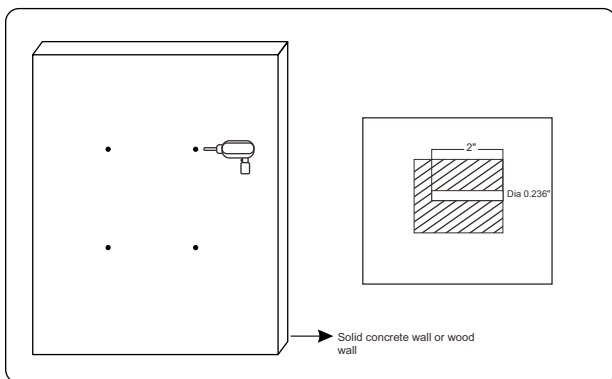

1. Drill four holes with a diameter of 0.236" and a depth of 2 inches.
Place the plate on the wall and use screws and wall anchors to secure the plate to the wall.

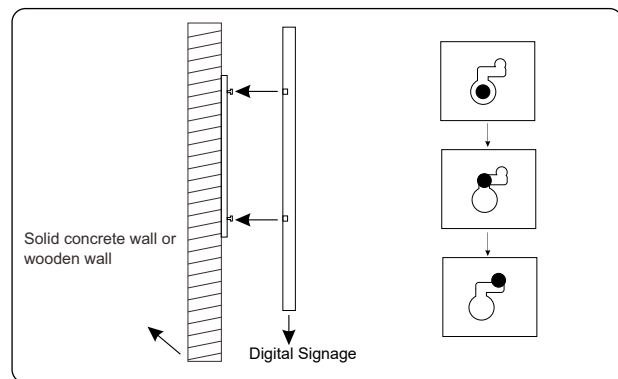

2. Connecting the holes on the digital signage to the raised posts on the plate and hang them to ensure that they are properly hung. Then move the digital signage to the right so that it is locked in the anti-theft hole.

Connect the power cord to the bottom of the unit with a power outlet.

Remote Control Instructions

The remote control is shown below:

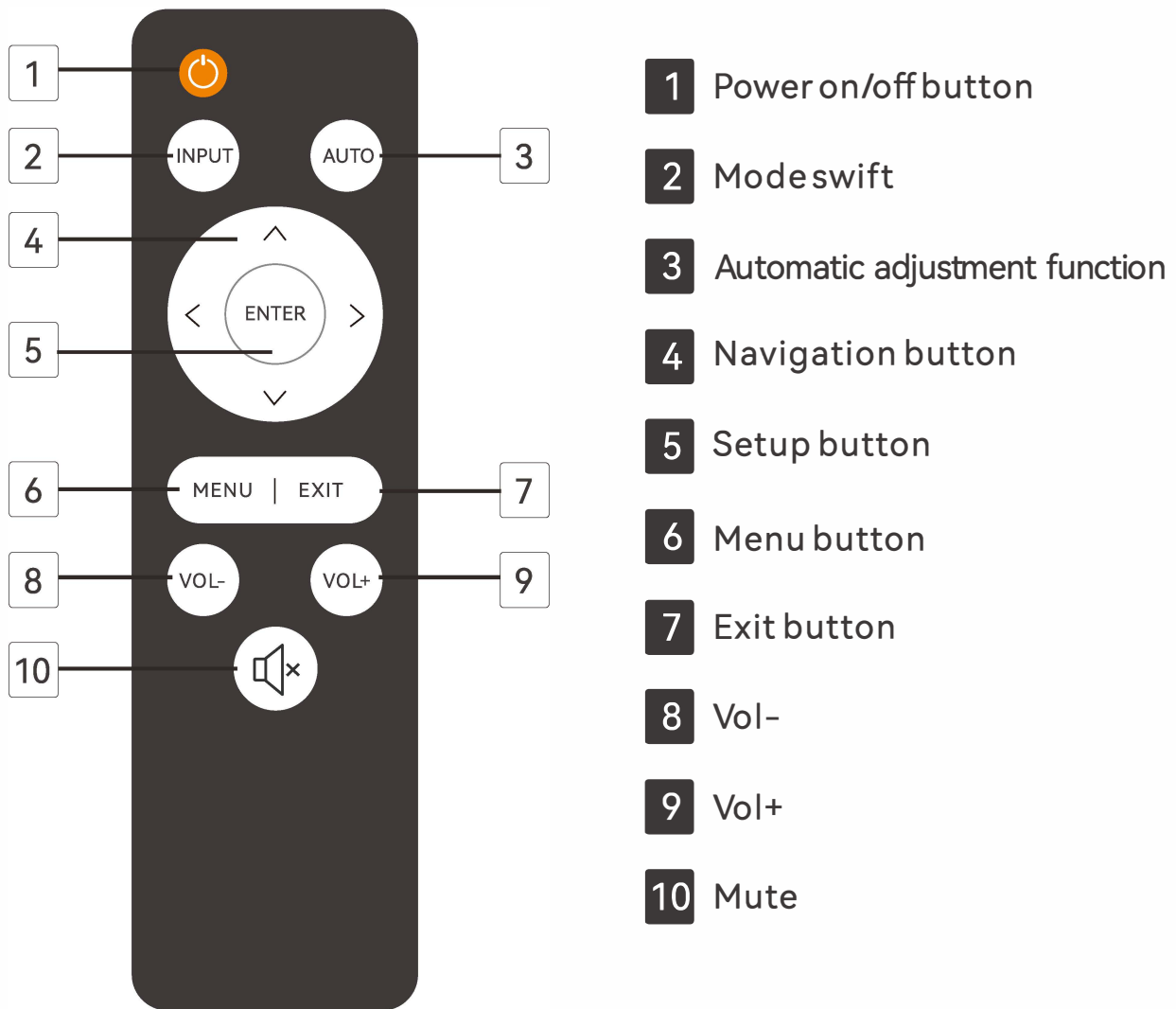

Description Of Basic Operation

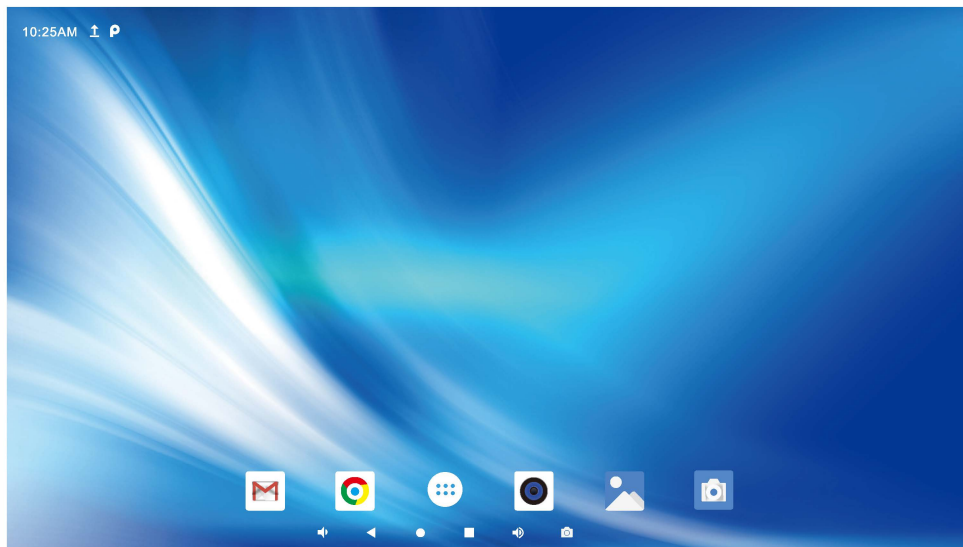





Android 11 operating system (RK3399)

Description Of Basic Operation







1. Functional description

- ◆ 1.1 In the navigation bar at the top of the machine, the following icons appear in different situations.

Icons	Description
	Connecting the network cable
	No 4G internet card inserted
	Turn on flight mode
	Turn on Bluetooth
	Connecting to WIFI

- ◆ 1.2 The navigation bar at the bottom of the machine helps you to operate it more easily.









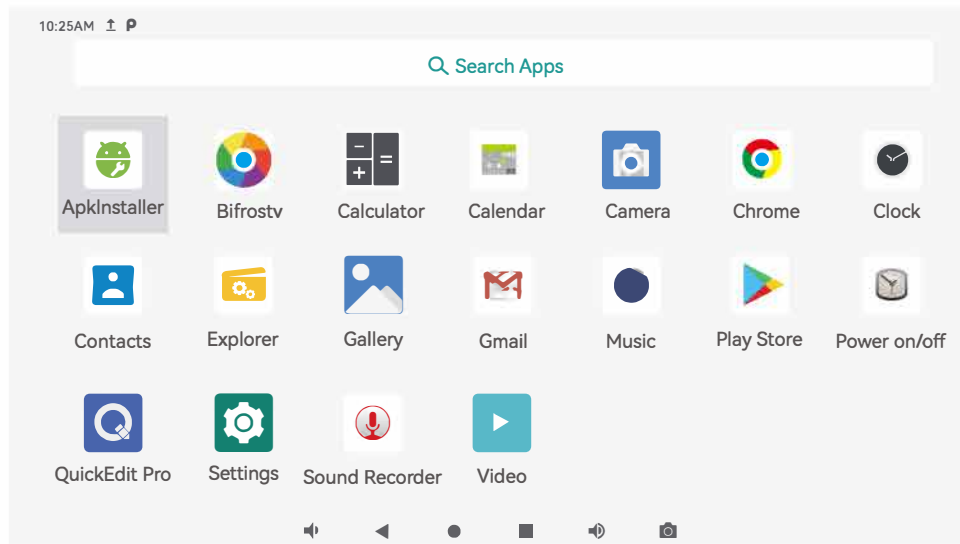



Icons	Description
	Home button
	Open uncleared background
	Exit button
	Volume down
	Volume up
	Screenshot function
	Hide the navigation bar

Description Of Basic Operation

◆ 1.3 Description of the application icons that come with the system.









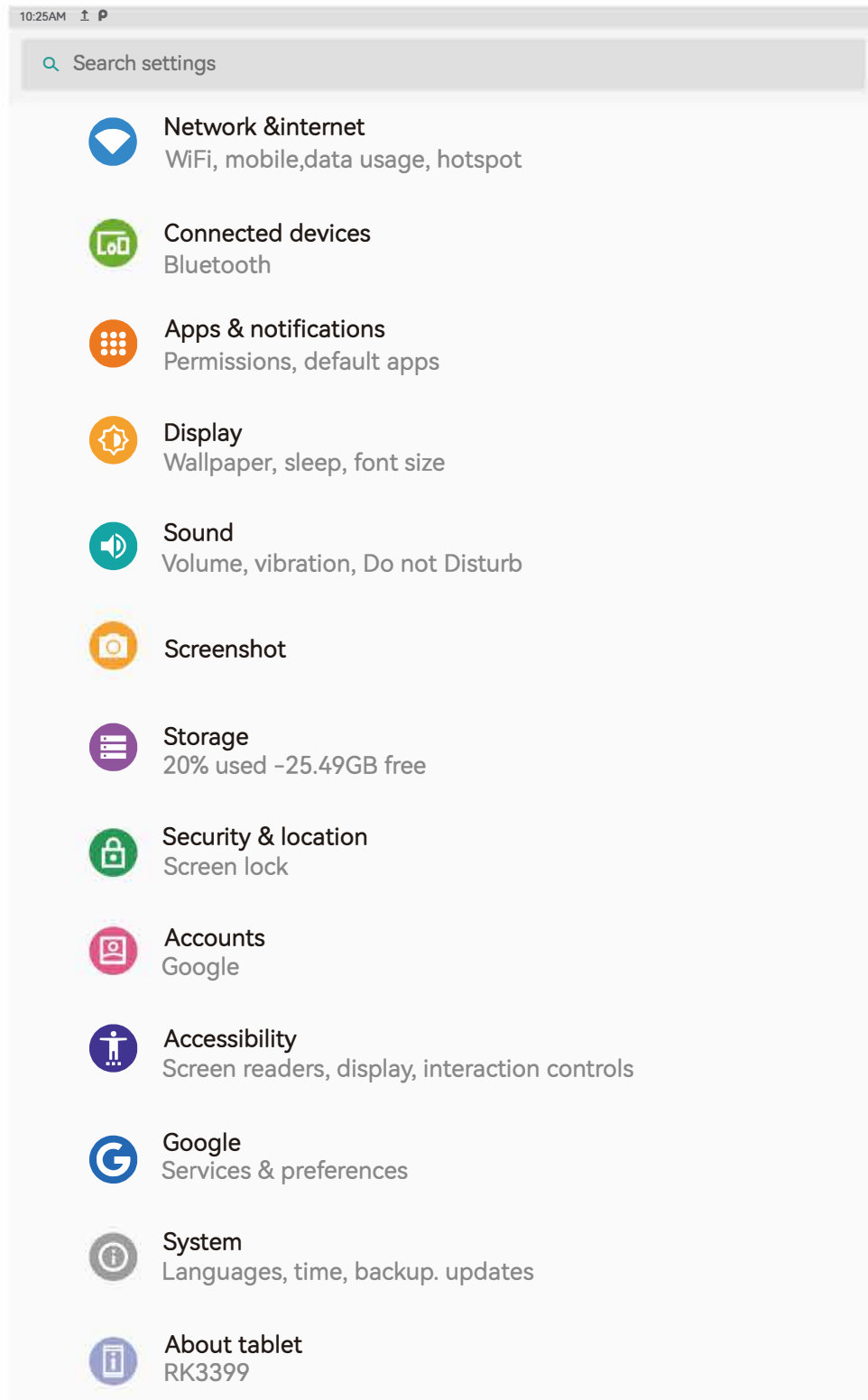

Icons	Description
	Open application bar.
	Google Play Store.
	File Manager.
	Timed on/off function (set on/off interval over 5 minutes).
	Settings (go to menu to set as required).
	Recorder: (requires machine with microphone) to record audio files.
	Video player: can support automatic reading and playback of videos from memory.
	APK Installer: This feature supports detection of app installers in the device storage and installation.
	Google Chrome: this browser can be used to access the web when connected to the internet.
	Camera (the device needs to be connected to a camera in order to use it): use the camera to take pictures, record videos and adjust the photo ratio in the camera settings.

Description Of Basic Operation

2.Introduction to system settings



Description Of Basic Operation

Icons	Description
 <p>Network & internet WiFi, mobile, data usage, hotspot</p>	Click the icon to enable the wifi function and connect to the detected wifi.
 <p>Connected devices Bluetooth</p>	Click the icon to enable the Bluetooth function and detect the surrounding Bluetooth devices.
 <p>Apps & notifications Permissions, default apps</p>	Click the icon to set the notification permission of the APP.
 <p>Display Wallpaper, sleep, font size</p>	Click the icon to set the following function options.
 <p>Sound Volume, vibration, Do not Disturb</p>	Tap to set the system volume and notification tone.
 <p>Screenshot</p>	Tap to enable the screen capture function.
 <p>Storage 20% used -25.49GB free</p>	Click to view the memory usage.
 <p>Security & location Screen lock</p>	Click to check the safety and location.
 <p>Accounts Google</p>	Click open to set mobile phone account.
 <p>Accessibility Screen readers, display, interaction controls</p>	Click open to set the barrier-free mode.
 <p>Google Services & preferences</p>	Click open to set Up Google.
 <p>System Languages, time, backup, updates</p>	Click "Open" to set language, time, backup and update.
 <p>About tablet rk3399</p>	You can view the specific information of your mobile phone.

Description Of Basic Operation

3.Function instructions

◆ 3.1. Network&internet set

Click on this icon  The following screen appears:

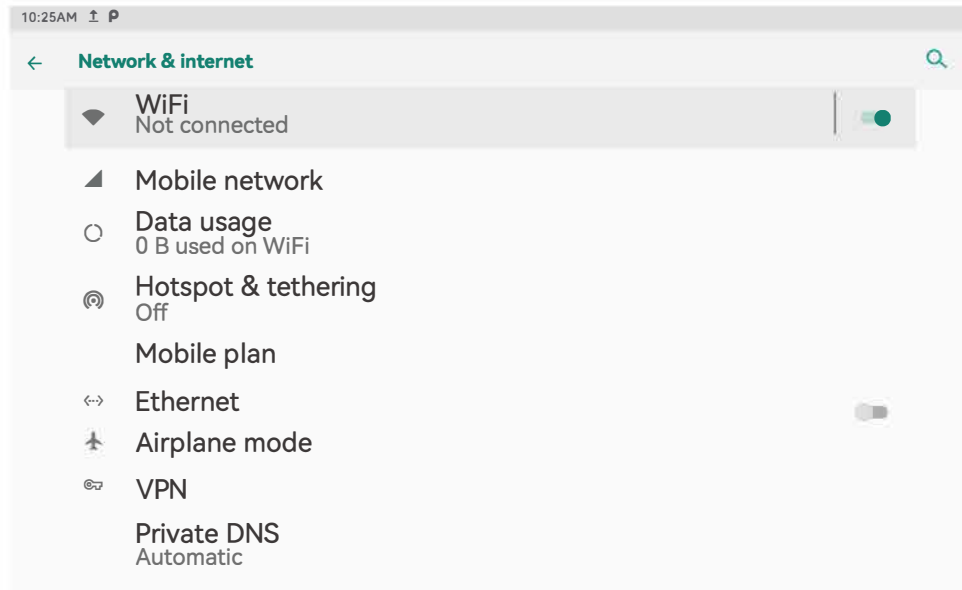

3.1.1 Click the WIFI option to connect to the wireless network. In addition, the WIFI is dual-frequency WIFI, which can connect to the wireless network of 2.4g and 5G band, giving users more choice experience.

3.1.2 Click "Modile Network" to select the mobile phone network; Data Usage displays the data usage. Click "hotspot" to open the hotspot.

3.1.3 Click "Ethernet" Ethernet option.

3.1.4 Click "Airplane Mode" to turn on or off airplane Mode.

Description Of Basic Operation

◆ 3.2. Connected Devices set

Click on this icon



Connected devices
Bluetooth

The following screen appears:

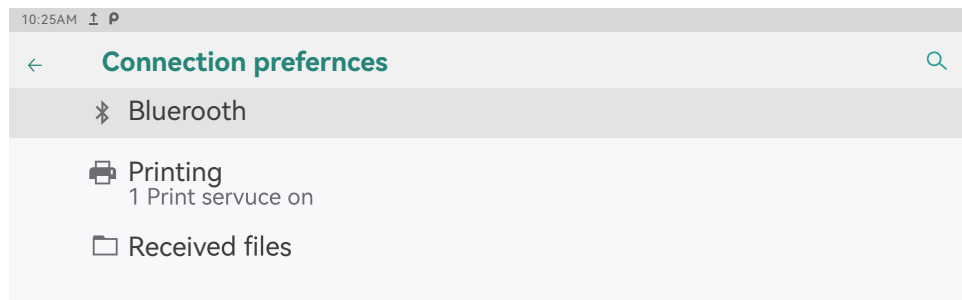

3.2.1 Click on this icon



You can select the desired Bluetooth device for data exchange.

3.2.2 Click on this icon

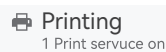

Can be connected to a print device.

3.2.3 Click on this icon



View the files you receive.

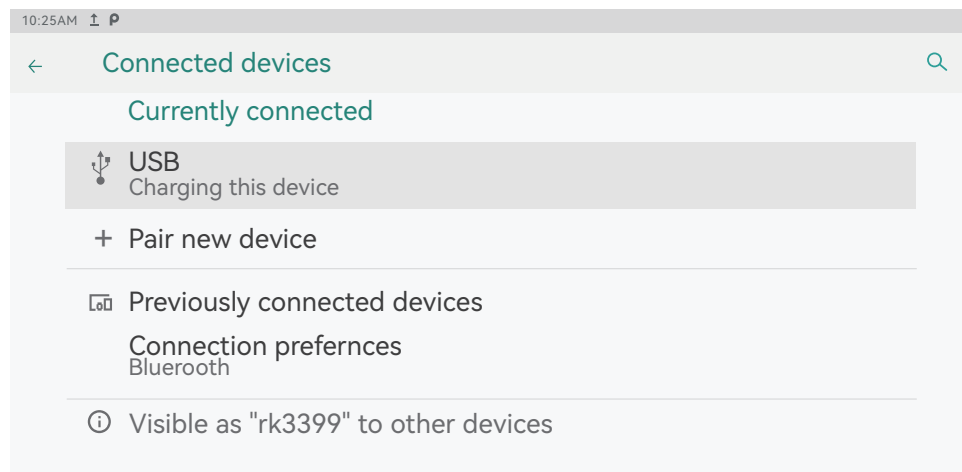

3.2.4 Click on this icon

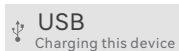

Option to set USB function.

3.2.5 Click on this icon



Use this option to add new devices.

3.2.6 Click on this icon

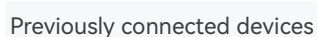

You can use this option to search for previously used devices.

3.2.7 Click on this icon

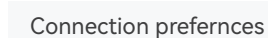

Connection preferences.

Description Of Basic Operation

◆ 3.3 System sound control



3 options to set the volume of music, call, alarm and notification in sequence.

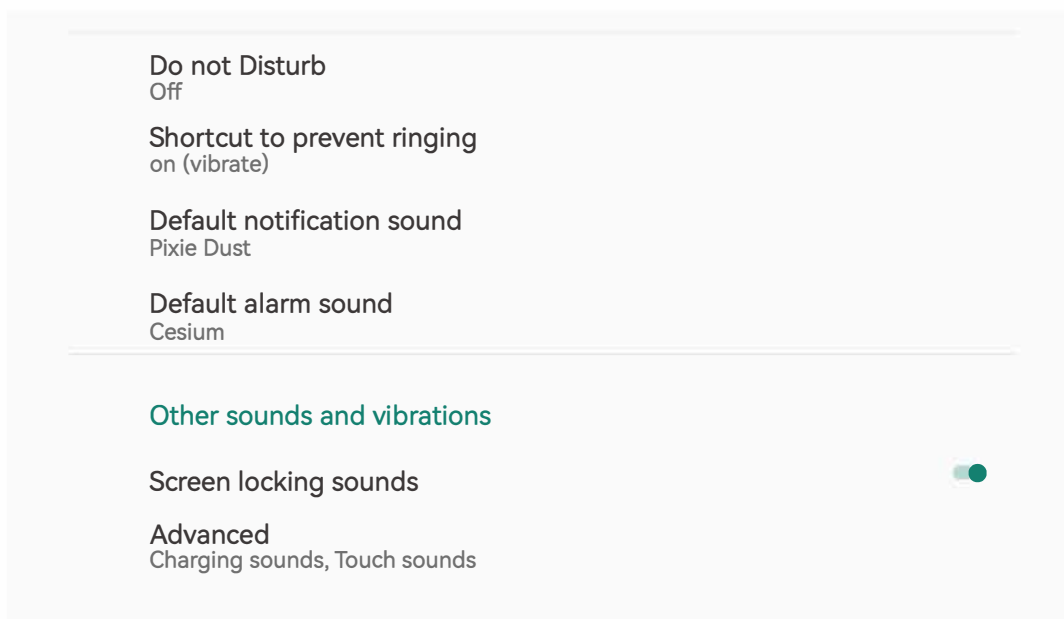

3.3.1 Click on this icon  Do not disturb mode Settings.

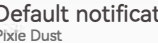
3.3.2 Click on this icon  Default Notification Sound.

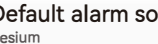
3.3.3 Click on this icon  Default Notification Sound.

3.3.4 Click on this icon  Screen lock sound.

Description Of Basic Operation

Click on this icon



About tablet
Rk3399

The following screen appears:

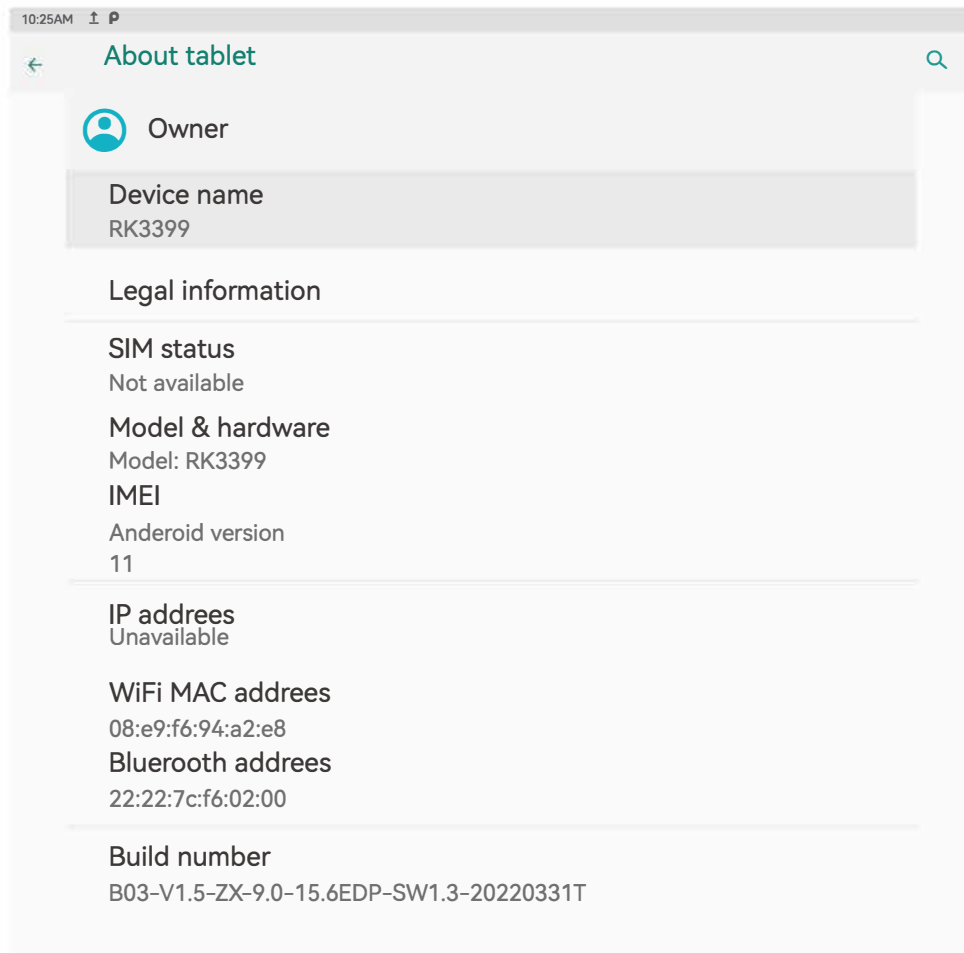

In this interface, you can see the device name, legal information, SIM status, model&hardware (model&hardware, IMEI), Android version, IP address, wifi MAC Address, Bluetooth Address and other information, version (build number)

Description Of Basic Operation

◆ 3. 4 Accessibility set

Click on this icon







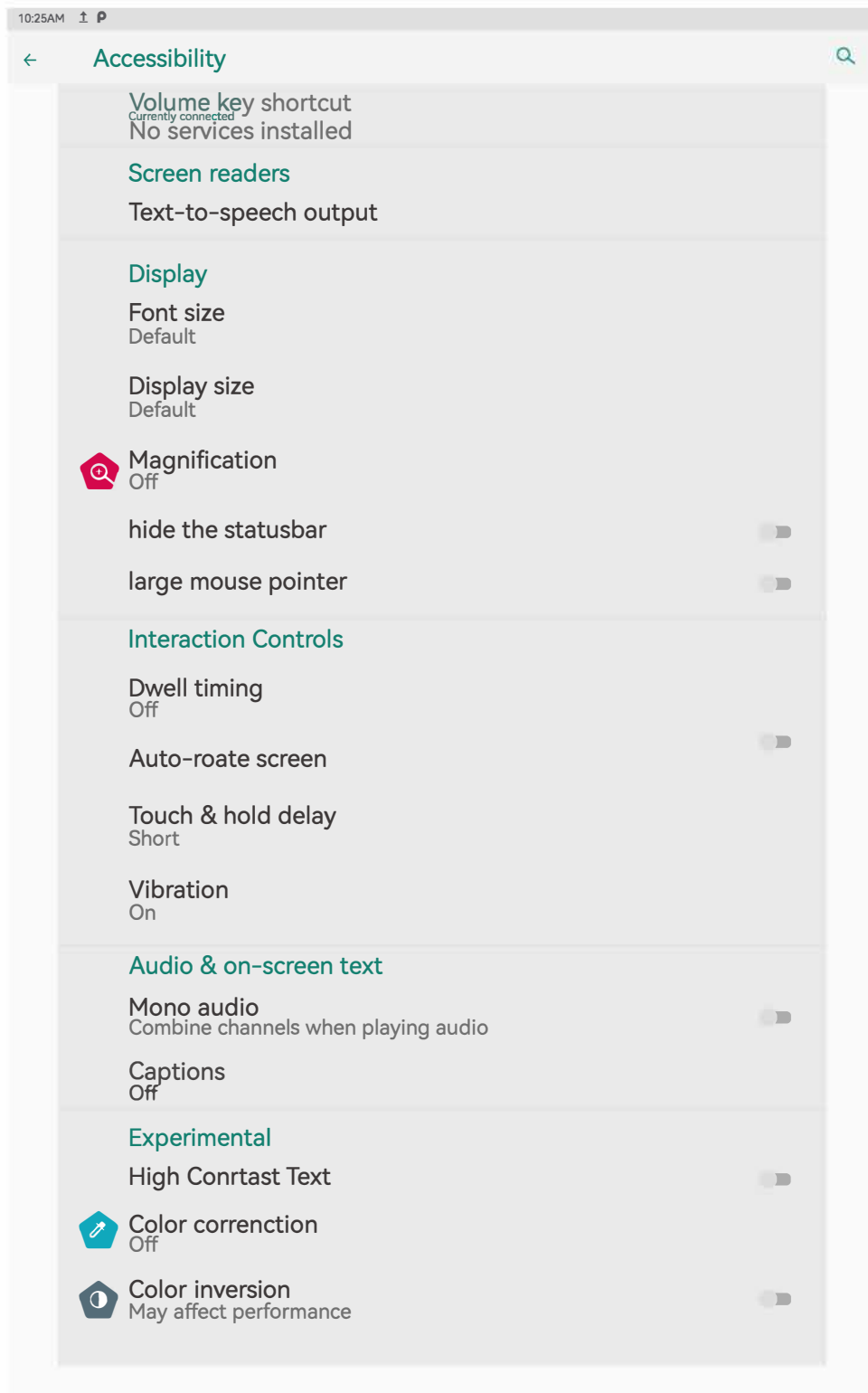



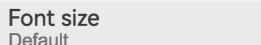
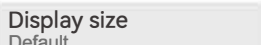
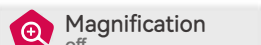

Accessibility
Screen readers, display,
interaction controls

The following screen appears:

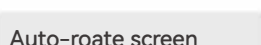

Description Of Basic Operation

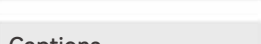
The following is a description of the options

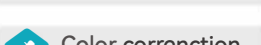
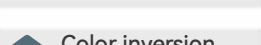



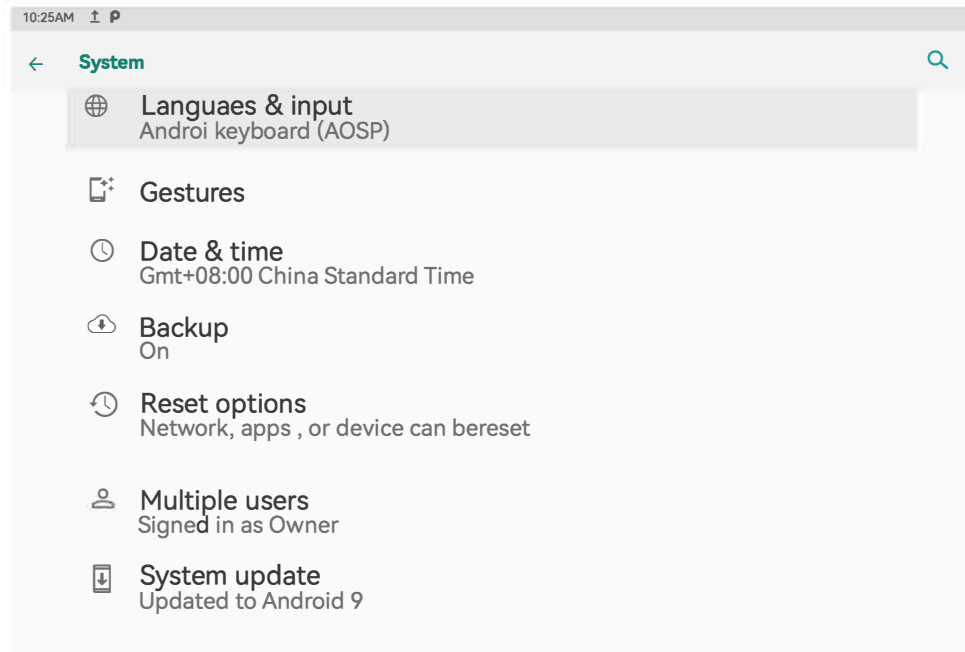

- | | | |
|--------|---|--|
| 3.4.1 |  Screen readers | Screen readers. |
| 3.4.2 |  Text-to-speech output | Text to Voice Output. |
| 3.4.3 |  Font size
Default | This option allows you to set any font size. |
| 3.4.4 |  Display size
Default | Set the display size. |
| 3.4.5 |  Magnification
off | Zoom in using this icon. |
| 3.4.6 |  hide the statusbar | Use this icon to display and hide the status bar. |
| 3.4.7 |  large mouse pointer | Pointer size can be achieved with this option. |
| 3.4.8 |  Auto-rotate screen | Automatic Screen rotation. |
| 3.4.9 |  Touch & hold delay | Touch and hold down the delay setting option. |
| 3.4.10 |  Vibration
on | You can use this parameter to set the vibration mode. |
| 3.4.11 |  Mono audio | Bluetooth mono audio. |
| 3.4.12 |  Captions | Subtitles can be used for this type selection. |
| 3.4.13 |  High Contrast Text | High contrast text. |
| 3.4.14 |  Color correction
off | Color correction. |
| 3.4.15 |  Color inversion
May affect performance | Color inversion function (Using this function may affect performance). |

Description Of Basic Operation

◆ 3.5. System Settings

Click on this icon  The following screen appears:



- 3.5.1  You can set the language of the system
- 3.5.2  Gestures This icon is set for gesture
- 3.5.3  Date & time Gmt+08:00 China Standard Time Set the date and time of the system
- 3.5.4  Backup On Data can be backed up
- 3.5.5  Reset options Network, apps, or device can bereset You can choose whether or not to reset the product
- 3.5.6  Multiple users Signed in as Owner Use a different account to log in
- 3.5.7  System update Updated to Android 9 System Upgrade Options

Description Of Basic Operation

◆ 3.6. Display Settings

Click on this icon  The following screen appears:

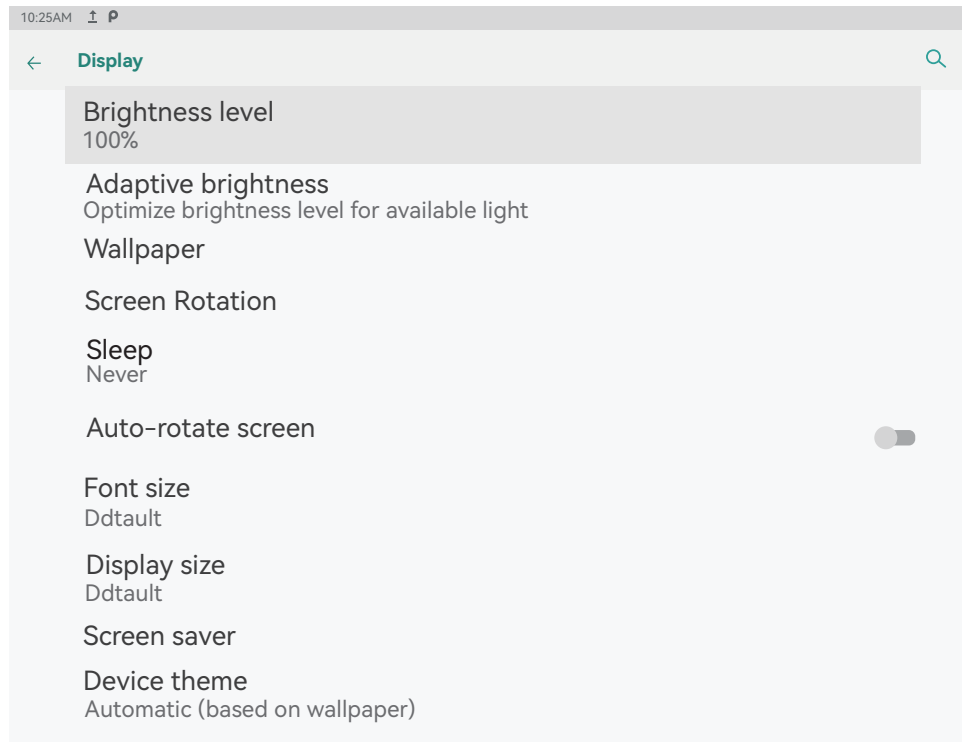

- | | | |
|--------|---|---|
| 3.6.1 | Brightness level
100% | Adjust the backlight brightness. |
| 3.6.2 | Adaptive brightness
Optimize brightness level for available light | Automatic brightness adjustment function. |
| 3.6.3 | Wallpaper | Wallpaper Settings. |
| 3.6.4 | Screen Rotation | Screen rotation. |
| 3.6.5 | Sleep
Never | dormancy. |
| 3.6.6 | Screen saver | Screen saver. |
| 3.6.7 | Display size
Ddtault | According to the size of the. |
| 3.6.8 | Font size
Ddtault | The font size. |
| 3.6.9 | Device theme
Automatic (based on wallpaper) | Equipment subject. |
| 3.6.10 | Auto-rotate screen | Auto - rotate the screen. |

DiViEx APP Introduction

System requirements:

Step 1: Before using this application, make sure your machine meets or exceeds the following system requirements:

CPU	RK3399
ROM	32GB
Operating system	Android 11

How to upload media files :

Step 2: Make new directory named "MediaFolder" in root directory in U disk.



Open "MediaFolder", create 3 subfolders, and change their names to "Images", "Videos", "Music". Copy the media file to be displayed, image to "Images", video to "Videos", Music to "Music"

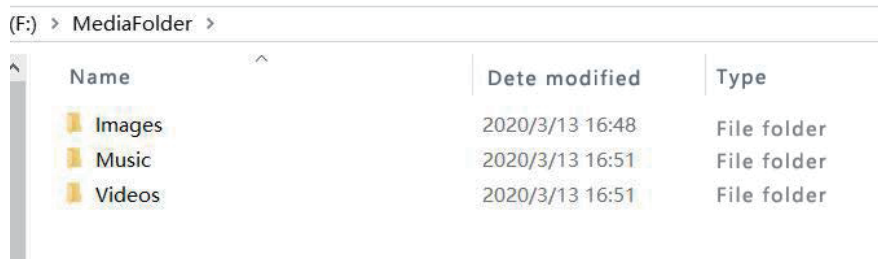

Format requirement:

Image	JPG/JPEG/BMP/PNG
Video	MPEG1/MPEG2/MPEG4/ MKV
Music	MP3

Step 3: Plug in the USB drive into the device and click the DiViEx App to open it.

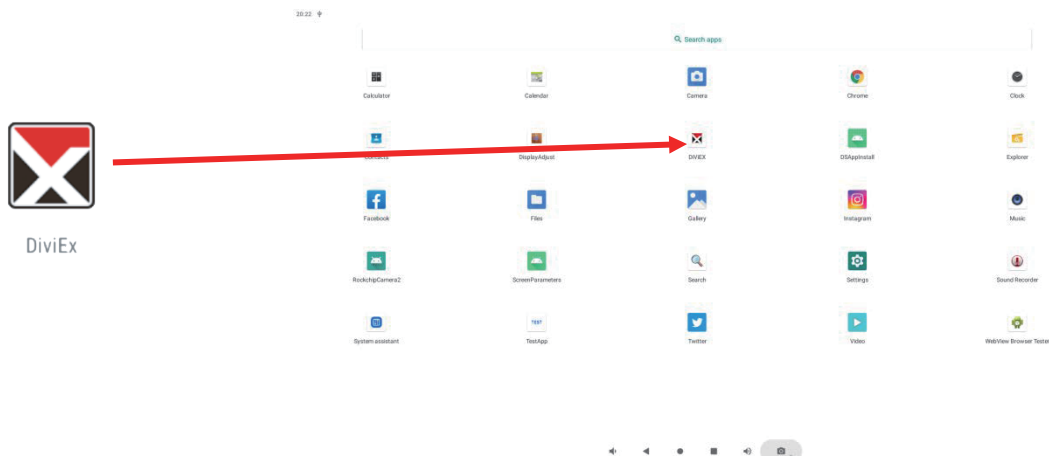

Step 4: When the screen shows “Copy finished” after “Usb Disk:”,

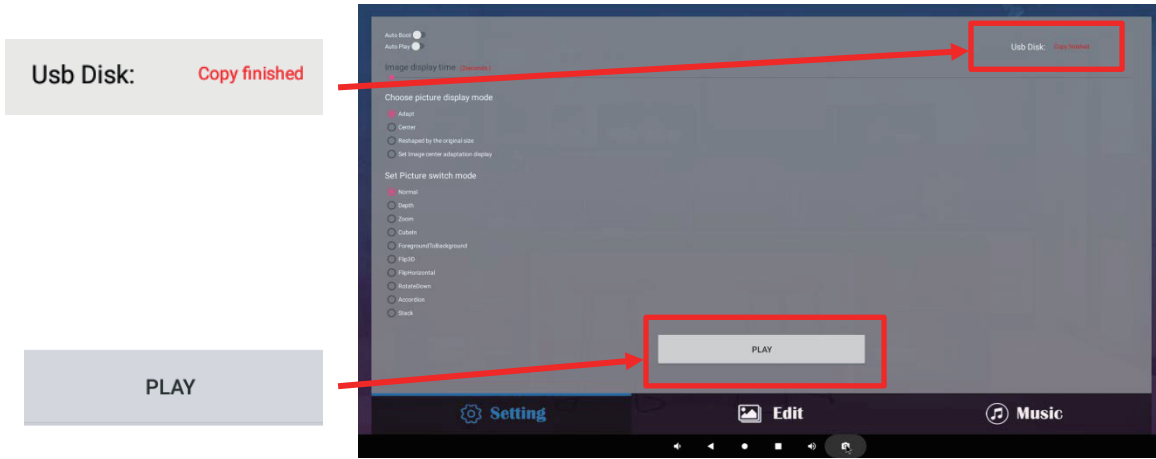

Setting:

Step 1: Select the time you would like each picture to be on the screen for by dragging the bar to the desired time. Select how you would like the images to display. Select the desired transition effect between pictures.

- **Auto Boot**
If enable, application will auto boot when android system boot
- **Auto Play**
If enable, application will show all resource including images, videos
- **Choose Picture display mode**
"Adapt", "Center", "Reshaped by the original size", "Set Image center adaptation display"
- **Set Picture switch mode**
During the image conversion process, there are 10 animations: "Normal", "Depth", "Zoom", "CubeIn", "Foreground To Background", "Flip3D", "Flip Horizontal", "Rotate Down", "Accordion, Stack".

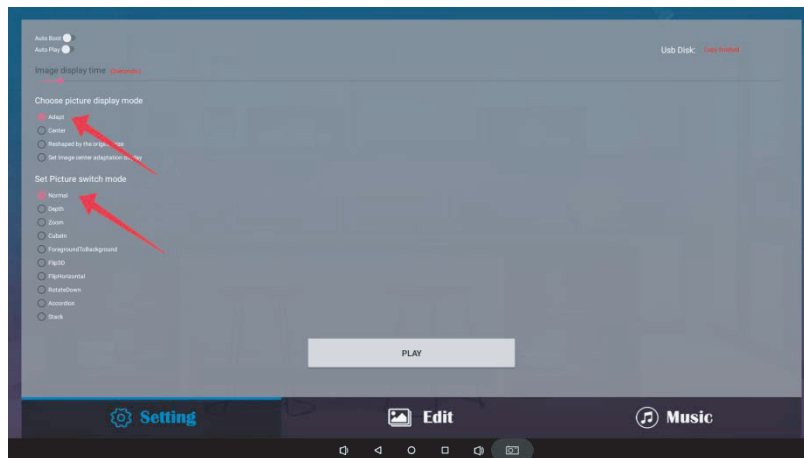

Edit picture:

This function show all pictures, you can edit all pictures, and remove it.

- **Edit picture (Crop)**

There are four corners and four border to crop the picture, you can drag it

- **Text**

You can add text to the picture

- **Filter**

Set different filter for the picture, we support the following filter: NOE, AUTO_FIX, BRIGHTNESS, CONTRAST, DOCUMENTARY, DUE_TONE, FILL_LIGHT, FISH_EYE, GRAIN, GRAY_SCALE, LOMISH, NEGATIVE, POSTERIZE, SATURATE, SEPIA, SHARPEN, TEMPERATURE, TINT, VIGNETTE, CROSS_PROCESS, BLACK_WHITE, FLIP_HORIZONTAL, FILP_VERTICAL, PSTERIZE, ROTATE.

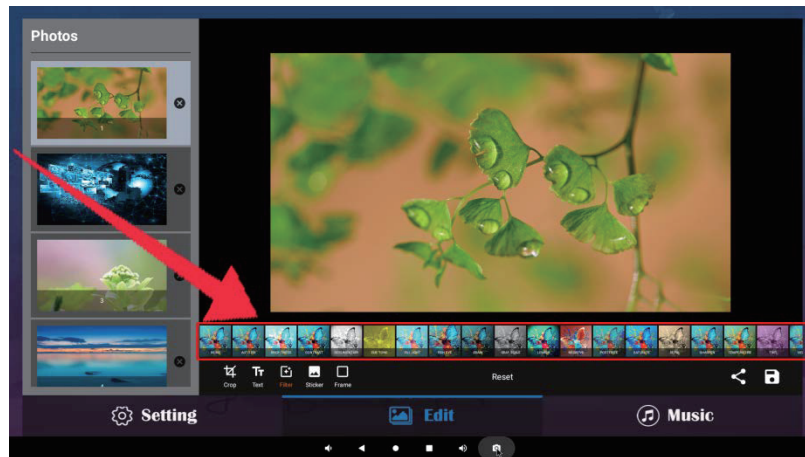

- **Sticker**

You can add seven special effects to the picture

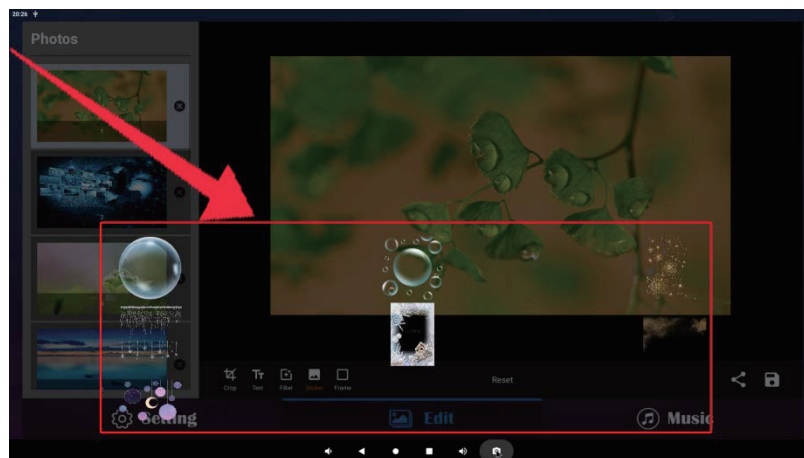

- **Frame**

You can add different borders to the picture

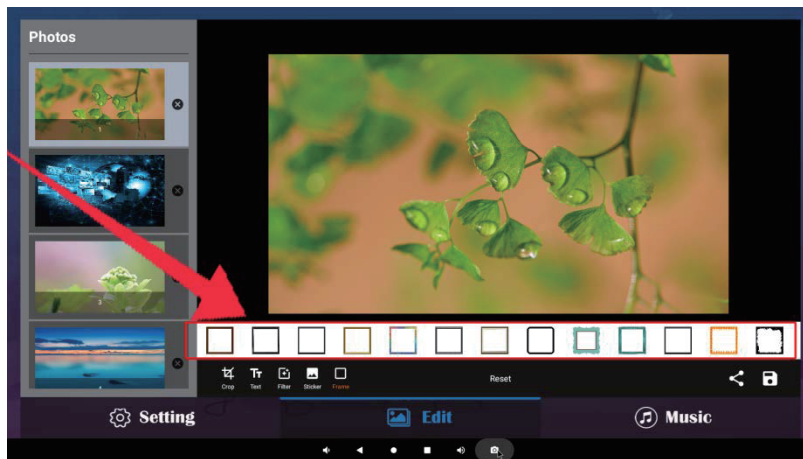

- **Reset**

Restore the original image

- **Picture sharing “”**

When you click the share button, you can share the picture to the corresponding APP

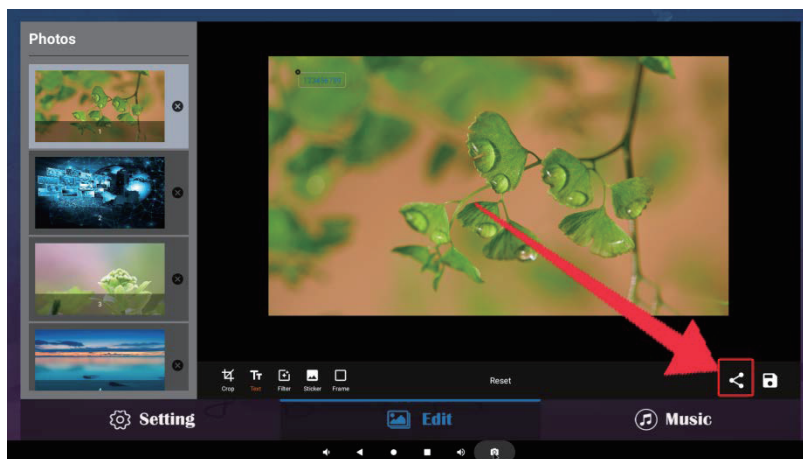

- **Pictures saving “”**

When you click the Save button, it will create a new picture

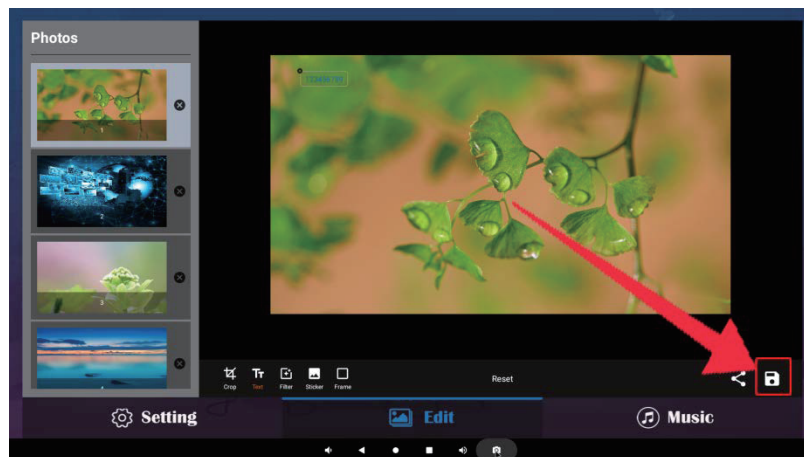

- **Image deletion**

Click "✕" to delete unwanted pictures

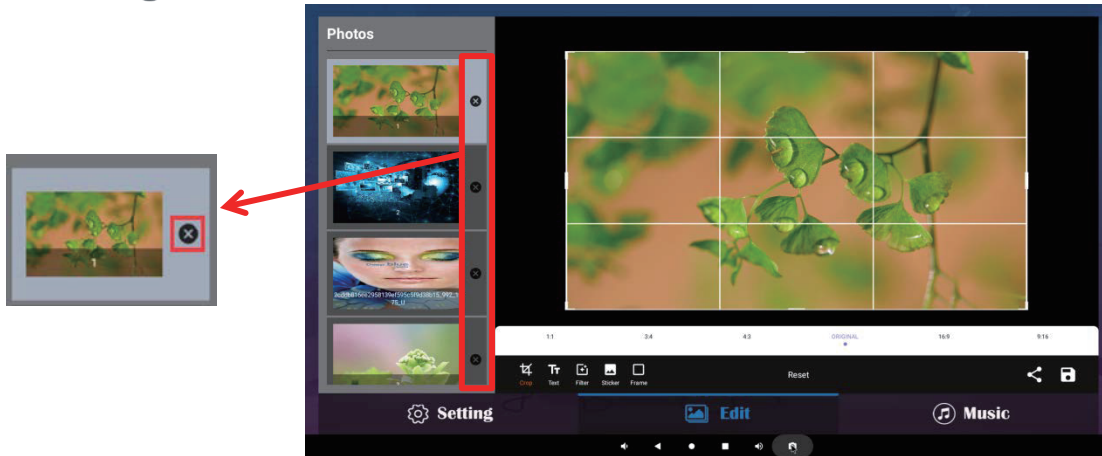

Music:

List all music files in Playlist library

- Add music to playing list music from Playlist library, you can click right arrow, music title will show the number of playlist music.
- To remove background music from the playlist, click the left arrow in the playlist

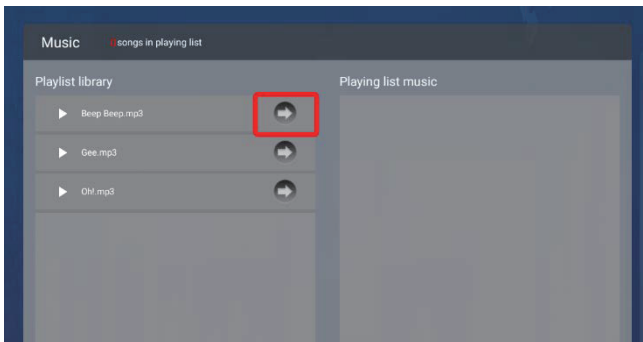

Fig. 1

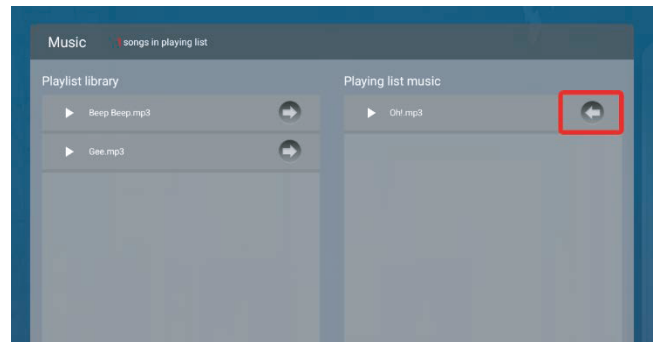

Fig. 2



Technical Specifications

	ITEM	SPECIFICATION
Panel	LCD size	32"
	Light source	WLED
	Resolution	1920*1080 (pixels)
	Brightness (typ.)/(min)	450cd /m ²
	Contrast (typ.)	1400:1
	Response (ms)	6ms
	Pixel pitch	0.36375×0.36375mm
	Refresh rate	60Hz
	Viewing angle	89°/89°/89°/89°
	Color saturation	68%
	Viewable area	27.50x22.54 in ()698.4×392.85 mm)
	Chromaticness	16.7M
Power supply	Voltage	AC100-240V
	Power Consumption	40W
Environment	Operating temperature	32~104 °F (0~40 °C)
	Storage temperature	-4~140 °F (-20~60 °C)
	Storage humidity	10~90% RH Non-condensing
	Operating humidity	10~90% RH Non-condensing
Functions	Operating system	Android 11
	Processor	Quad-core ARM Cortex-A72, 1.8GHz
	RAM	4G
	Built-in memory	32G
	Decoding resolution	1080P FHD compatible
	Playback mode	Yes
	Touch support	Yes

Functions	Supported Video Files	RMVB, FLV, MPEG1/2/4, AVI, DIVX, XDIV, WMV9, H.264, VC-1, MOV, MKV, MP4, TS, M2T
	Supported Photo Files	BMP/PNG/GIF/JPEG
	Supported Audio files	MP3, WMA, WAV, AAC+, MP2 dec, Vorbis (Ogg), AC3, FLAC, APE, BSAC;
	RTC (real-time clock)	Yes
	Schedule power on/off	Yes
	System update	Yes
	App installation	Support download and installation
I/O interfaces	Ethernet (RJ45)	1
	HDMI Output	1
	USB2.0	2
	TF	1
	SIM	1
	Audio	1
Structure	Net weight	22 lbs
	Gross weight	60 lbs
	Unit dimensions	40.55x17.71x0.78 in
	Package dimensions	47.63x26.77x7.87 in
	Shell material	Metal
	Shell color	Black
Language	OSD	English

Troubleshooting the Digital Signage

Issue	Probable Cause	Solutions
<ul style="list-style-type: none"> ● No picture or sound 	<ul style="list-style-type: none"> ➤ Unit not plugged into wall outlet ➤ Power cord not properly connected to the terminal on the back of the unit. ➤ Unit not powered on ➤ Wall outlet not working 	<ul style="list-style-type: none"> ☐ Check that the unit is plugged into wall outlet. ☐ Confirm that the power cord is connected to the terminal on the back of the unit. ☐ Turn the on/off toggle switch located on the back of the unit, lower center, to the “on” position. ☐ Unplug unit, wait 20 seconds, plug unit back into outlet and try again. ☐ Make sure that outlet is working by plugging in a different electrical device. ❖ If all of the above have been checked and the issue is not resolved, contact a customer service representative.
<ul style="list-style-type: none"> ● No sound (but picture is working) 	<ul style="list-style-type: none"> ➤ Volume not adjusted on the remote control. ➤ Content/Video does not have sound. ➤ Content format is not compatible. ➤ Speakers do not work. 	<ul style="list-style-type: none"> ☐ Adjust volume using the remote control ☐ Confirm content is one of the following compatible formats: AVI, MPEG4, WMV, MKV, flv, MP3, MP4, MOV. ☐ If unit is connected to Wi-Fi, go to YouTube and play video that has sound ☐ Unplug unit, wait 20 seconds, plug unit back into outlet and try again. ☐ Try playing the content on a different device (smart phone, computer or tablet) ❖ If all of the above have been checked and the issue is not resolved, contact a customer service representative.
<ul style="list-style-type: none"> ● No picture (but sound is working) 	<ul style="list-style-type: none"> ➤ Content file damaged. ➤ Content format is not compatible. ➤ Screen damaged or defective. 	<ul style="list-style-type: none"> ☐ Confirm content is one of the following compatible formats: AVI, MPEG4, WMV, MKV, flv, MP3, MP4, MOV. ☐ Try playing the content on a different device (smart phone, computer or tablet) ☐ Unplug unit, wait 20 seconds, plug unit back into outlet and try again. ❖ If all of the above have been checked and the issue is not resolved, contact a customer service representative.
<ul style="list-style-type: none"> ● Remote control not working 	<ul style="list-style-type: none"> ➤ Batteries not inserted properly. ➤ Batteries are dead. ➤ Standing too close or too far from the unit. 	<ul style="list-style-type: none"> ☐ Check that battery is inserted properly with positive and negative orientation. ☐ Insert new batteries. ☐ Stand within 1 foot of the front of the unit and point the remote directly at the sensor (green dot) ❖ If all of the above have been checked and the issue is not resolved, contact a customer service representative.

<ul style="list-style-type: none"> ● No Wi-Fi signal 	<ul style="list-style-type: none"> ➤ Wi-Fi is not turned on in product settings. ➤ Wi-Fi is not connected to a network ➤ Low or no signal from the router ➤ Antenna is missing or not pointed upward. ➤ Damaged PC board 	<ul style="list-style-type: none"> □ Check that Wi-Fi is turned on in settings <ul style="list-style-type: none"> ○ Click the settings icon from the Android home screen.  ○ Click "Wi-Fi". ○ Click the on/off icon in the upper right hand corner to turn on Wi-Fi.  ○ "On" will appear on the upper left hand side. ○ Then select your Wi-Fi network □ Confirm that the antenna is in place and pointed upward. □ Check that other devices are receiving the signal. <ul style="list-style-type: none"> ○ If other devices are not receiving the Wi-Fi signal, please contact your internet service provider. □ Unplug or reset the router and wait for 20 seconds. Restart the router and check. ❖ If all of the above have been checked and the issue is not resolved, contact a customer service representative.
<ul style="list-style-type: none"> ● Parts missing or Damaged 	<ul style="list-style-type: none"> ➤ Parts missed during manufacturing. (No charge for replacements) ➤ Parts lost or damaged by the customer. (There is charge for replacements) 	<ul style="list-style-type: none"> ❖ Contact a customer service representative.
<ul style="list-style-type: none"> ● Having problems with installing software or getting content to play 	<ul style="list-style-type: none"> ➤ Did you purchase the DisplayIt!Xpress software from Displays2go? ➤ Did the customer purchase or downloaded another 3rd party software onto the product? 	<ul style="list-style-type: none"> □ If you purchased DisplayIt!Xpress software from Displays2go or from Best Wave directly, please contact Best Wave at support@bestwave.com or (480)368-8900 ext. 2 □ If you purchased or downloaded another 3rd party software onto the product, please contact the 3rd party software company's customer support for assistance.
<ul style="list-style-type: none"> ● Cannot upload content 	<ul style="list-style-type: none"> ➤ Content format is not compatible. ➤ Content files are too large. ➤ Port being used is defective ➤ App being used to play content is defective. ➤ Android board is defective. 	<p>Confirm content is one of the following compatible formats: AVI, MPEG4, WMV, MKV, flv, MP3, MP4, MOV.</p> <ul style="list-style-type: none"> ❖ Confirm file size is less than available space. ❖ If all of the above have been checked and the issue is not resolved, contact a customer service representative.
<ul style="list-style-type: none"> ● Issues using 	<ul style="list-style-type: none"> ➤ Mistake in storing content to 	<p>SlideShow App steps Explorer > Select USB ></p>

pre-installed apps	<p>NAND Flash (shown on pg. 11)</p> <ul style="list-style-type: none"> ➤ App is defective ➤ Android board is defective. 	<p>Select Multi > highlight files > Editor > Select Copy > Home > NAND > MediaFolder > Images> Editor > Paste</p> <ul style="list-style-type: none"> ○ Open SlideShow app and select desired transitions, slide time and looping > Play <p>MX Player steps > Follow same steps as SlideShow App > MediaFolder > Video > Editor > Paste.</p> <ul style="list-style-type: none"> ○ Open MX Player and select video to play. ○ Loop video: While the video is playing, click on the video and there should be 3 dots in the top right corner. Click on the 3 dots > play > check desired Loop option <p>If all of the above have been checked and the issue is not resolved, contact a customer service representative.</p>
--------------------	---	--

Cleaning and Maintenance

1. Avoid strong vibration or impact on the product.
2. Keep the product dry to avoid possible damage by moisture.
3. Don't place the product under direct sunlight which may shorten the service life of the screen.
4. Clean screen and product by using a glass cleaner.
5. If the product will not be used for a long time, pull out the power cord to prevent the internal short circuit or other potential dangers.

Names and Contents of Toxic and Hazardous Substances or Elements in the Product

Part name	Toxic and hazardous substances or elements					
	Pb	Hg	Cd	Cr6+	PBB	PBDE
Display		O	O	O	O	O
Shell	O	O	O	O	X	X
Circuit board assembly *		O	O	O	O	O
Wires	O	O	O	O	O	O
Metal parts	O	O	O	O	O	O
Packaging materials*	O	O	O	O	O	O
Remote control		O	O	O	O	O
Speaker		O	O	O	O	O
Accessories*	O	O	O	O	O	O

*: Circuit board assembly includes PCB and the electronic elements thereof;

Packaging materials include packaging box, styrofoam, etc.;

Other accessories include instruction manual.

O: the content of the toxic and hazardous substances or elements in the part is lower than the limit specified in GB/T 26572-2011 standard.

x: the content of the toxic and hazardous substances or elements in the part is higher than the limit specified in GB/T 26572-2011 standard.

The table shows that the machine containsharmful substances inside. The data is provided by material suppliers and verified by the company according to the material type. Some materials contain harmful substances that can't be replaced in present technology. We are dedicated to improving this.

The EFUP of the product is ten years. The pollution control label is shown on the right. 

The EFUP is valid only when the user operates in the normal conditions specified in the manual herein.

Waste Electrical and Electronic Products Recycling and Disposal Regulations

To protect the earth, if you do not need this product or its service life expires, please abide by your local Waste Electrical and Electronic Products Recycling and Disposal Regulations or send it to a qualified local manufacture for recycling.

Do not attempt to disassemble this product. If the product does not work properly, please call our Customer Service Department at 1-844-221-3393.

This Manual is for reference only and is subject to change without prior notice. Visit Displays2go.com for the latest product information and User Manual updates.